

Article number: 2310306975

Description: E+G Levelling element
LV.A-125-APS-M24x155

Measures

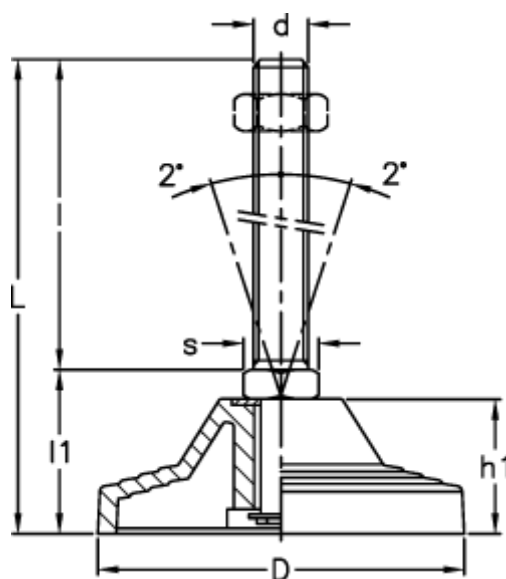

d	= M24
D	= 125
h	= 45
l	= 155
L	= 210
l1	= 55
Max load (N)	= 40000
s	= 24